

N-Channel Super Trench II Power MOSFET

Description

The series of devices uses **Super Trench II** technology that is uniquely optimized to provide the most efficient high frequency switching performance. Both conduction and switching power losses are minimized due to an extremely low combination of $R_{DS(ON)}$ and Q_g . This device is ideal for high-frequency switching and synchronous rectification.

Application

- DC/DC Converter
- Ideal for high-frequency switching and synchronous rectification

General Features

- $V_{DS} = 85V, I_D = 100A$
 $R_{DS(ON)} = 5.4m\Omega$, typical (TO-220) @ $V_{GS} = 10V$
 $R_{DS(ON)} = 5.4m\Omega$, typical (TO-263) @ $V_{GS} = 10V$
- Excellent gate charge x $R_{DS(on)}$ product(FOM)
- Very low on-resistance $R_{DS(on)}$
- 175 °C operating temperature
- Pb-free lead plating

100% UIS TESTED!
100% ΔVds TESTED!

TO-252

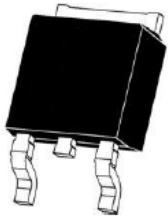

top view

DFN5X6-8L



Top View

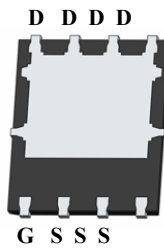

Bottom View

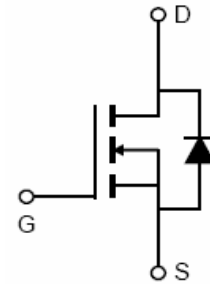

Schematic Diagram

Package Marking and Ordering Information

Device Marking	Device	Device Package	Reel Size	Tape width	Quantity
HMS100N85K	HMS100N85K	TO-252	-	-	-
HMS100N85G	HMS100N85G	DFN5X6-8L	-	-	-

Absolute Maximum Ratings ($T_C = 25^\circ C$ unless otherwise noted)

Parameter	Symbol	Limit	Unit
Drain-Source Voltage	V_{DS}	85	V
Gate-Source Voltage	V_{GS}	± 20	V
Drain Current-Continuous	I_D	100	A
Drain Current-Continuous($T_C = 100^\circ C$)	$I_D(100^\circ C)$	70	A
Pulsed Drain Current	I_{DM}	300	A
Maximum Power Dissipation	P_D	200	W
Derating factor		1.33	W/°C
Single pulse avalanche energy ^(Note 5)	E_{AS}	1050	mJ
Operating Junction and Storage Temperature Range	T_J, T_{STG}	-55 To 175	°C

Thermal Characteristic

Thermal Resistance, Junction-to-Case ^(Note 2)	$R_{\theta JC}$	0.75	$^{\circ}\text{C/W}$
--	-----------------	------	----------------------

Electrical Characteristics ($T_C=25^{\circ}\text{C}$ unless otherwise noted)

Parameter	Symbol	Condition	Min	Typ	Max	Unit	
Off Characteristics							
Drain-Source Breakdown Voltage	BV_{DSS}	$V_{GS}=0V, I_D=250\mu A$	85		-	V	
Zero Gate Voltage Drain Current	I_{DSS}	$V_{DS}=85V, V_{GS}=0V$	-	-	1	μA	
Gate-Body Leakage Current	I_{GSS}	$V_{GS}=\pm 20V, V_{DS}=0V$	-	-	± 100	nA	
On Characteristics ^(Note 3)							
Gate Threshold Voltage	$V_{GS(th)}$	$V_{DS}=V_{GS}, I_D=250\mu A$	2.0	3.0	4.0	V	
Drain-Source On-State Resistance	$R_{DS(on)}$	$V_{GS}=10V, I_D=70A$	TO-220	-	5.4	6.5	m Ω
			TO-263		5.4	6.5	m Ω
Forward Transconductance	g_{FS}	$V_{DS}=5V, I_D=70A$		90	-	S	
Dynamic Characteristics ^(Note 4)							
Input Capacitance	C_{iss}	$V_{DS}=40V, V_{GS}=0V,$ $F=1.0\text{MHz}$	-	4950	-	PF	
Output Capacitance	C_{oss}		-	850	-	PF	
Reverse Transfer Capacitance	C_{rss}		-	40	-	PF	
Switching Characteristics ^(Note 4)							
Turn-on Delay Time	$t_{d(on)}$	$V_{DD}=40V, I_D=70A$ $V_{GS}=10V, R_G=1.6\Omega$	-	18	-	nS	
Turn-on Rise Time	t_r		-	11	-	nS	
Turn-Off Delay Time	$t_{d(off)}$		-	38	-	nS	
Turn-Off Fall Time	t_f		-	9	-	nS	
Total Gate Charge	Q_g	$V_{DS}=40V, I_D=70A,$ $V_{GS}=10V$	-	88	-	nC	
Gate-Source Charge	Q_{gs}		-	22		nC	
Gate-Drain Charge	Q_{gd}		-	25		nC	
Drain-Source Diode Characteristics							
Diode Forward Voltage ^(Note 3)	V_{SD}	$V_{GS}=0V, I_S=70A$	-		1.2	V	
Diode Forward Current ^(Note 2)	I_S		-	-	100	A	
Reverse Recovery Time	t_{rr}	$T_J = 25^{\circ}\text{C}, I_F = 70A$ $di/dt = 100A/\mu s$ ^(Note 3)	-	72	-	nS	
Reverse Recovery Charge	Q_{rr}		-	102	-	nC	

Notes:

1. Repetitive Rating: Pulse width limited by maximum junction temperature.
2. Surface Mounted on FR4 Board, $t \leq 10$ sec.
3. Pulse Test: Pulse Width $\leq 300\mu s$, Duty Cycle $\leq 2\%$.
4. Guaranteed by design, not subject to production
5. EAS condition : $T_J=25^{\circ}\text{C}, V_{DD}=40V, V_G=10V, L=0.5\text{mH}, R_G=25\Omega$

Typical Electrical and Thermal Characteristics

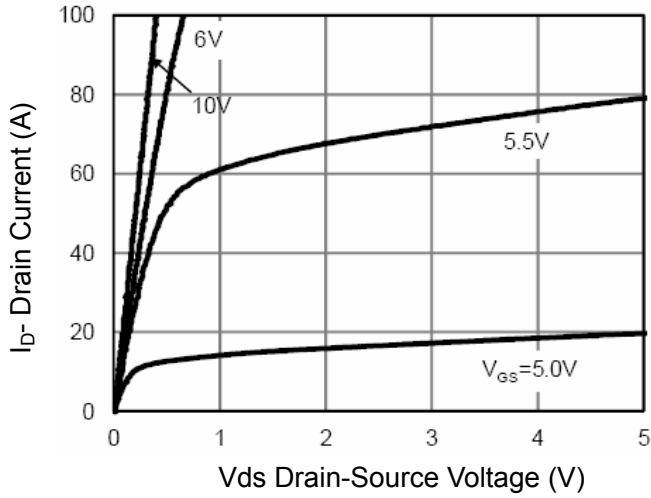

Figure 1 Output Characteristics

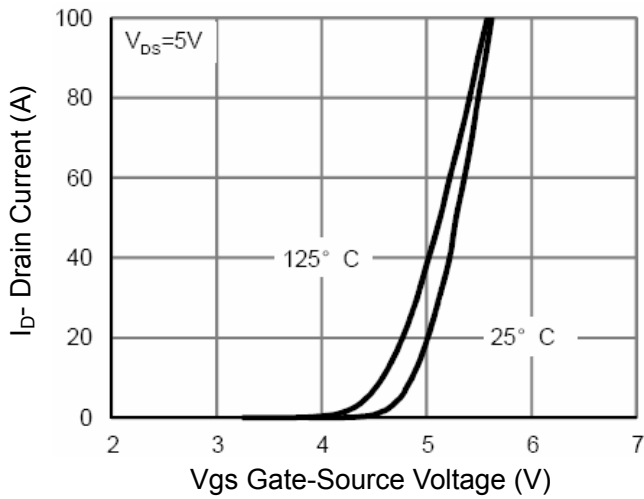

Figure 2 Transfer Characteristics

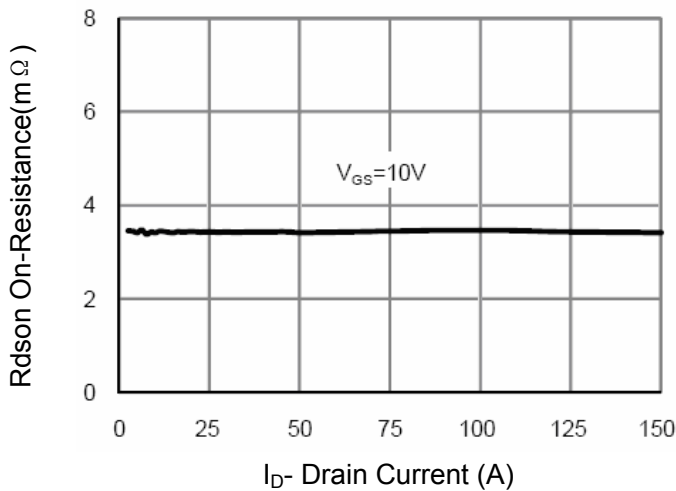

Figure 3 Rdson- Drain Current

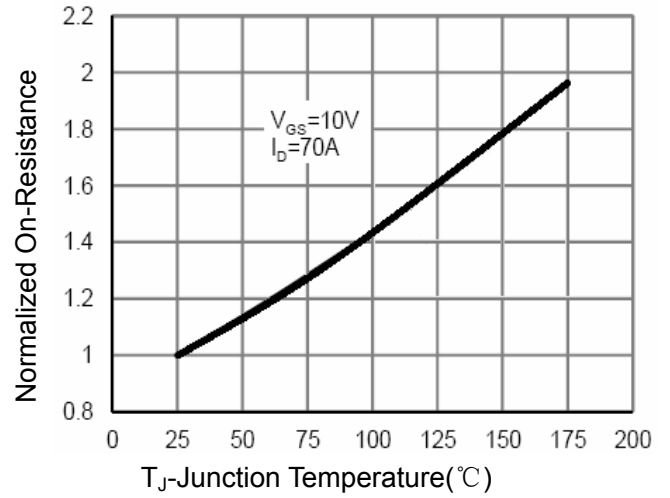

Figure 4 Rdson-Junction Temperature

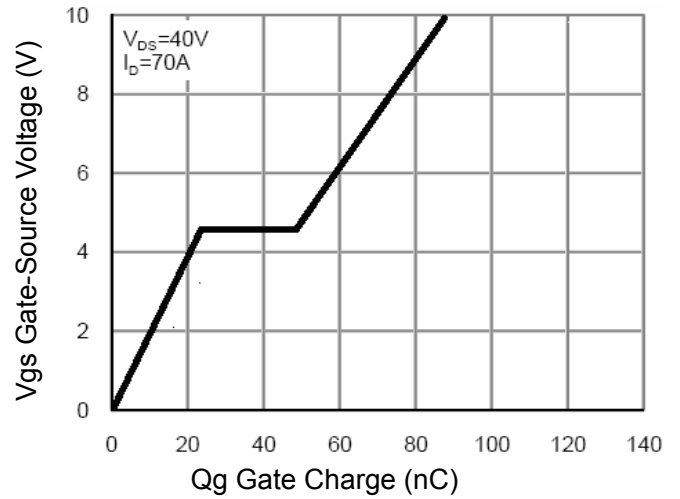

Figure 5 Gate Charge

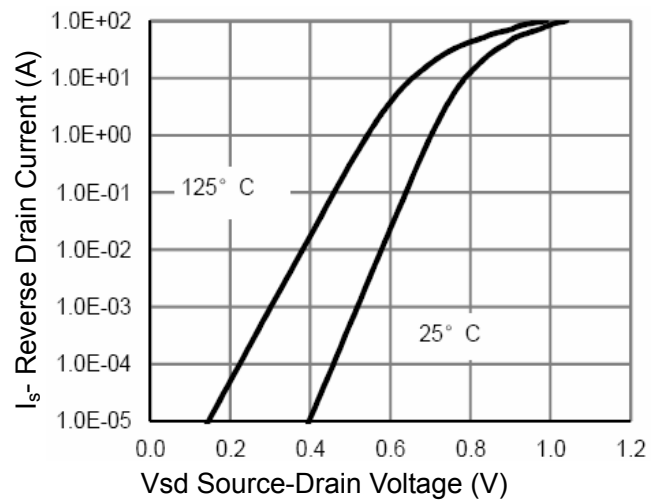

Figure 6 Source- Drain Diode Forward

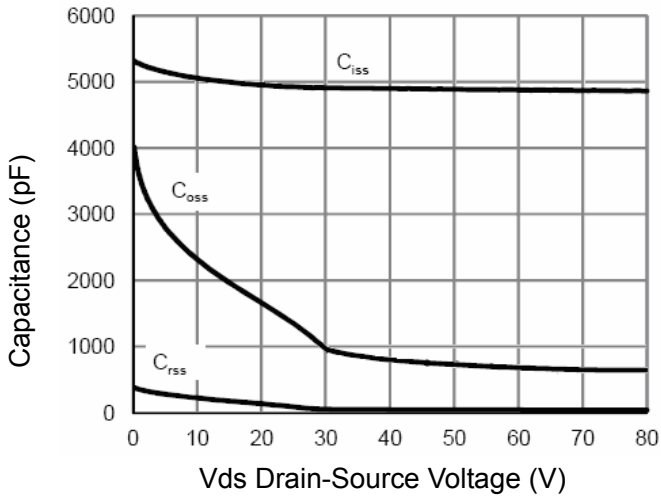

Figure 7 Capacitance vs Vds

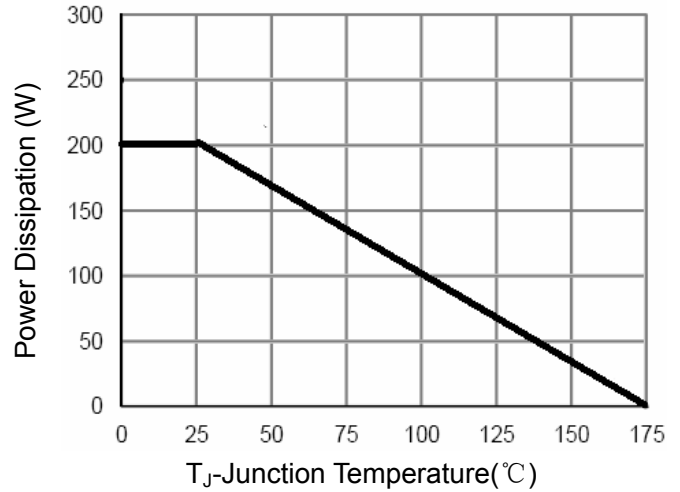

Figure 9 Power De-rating

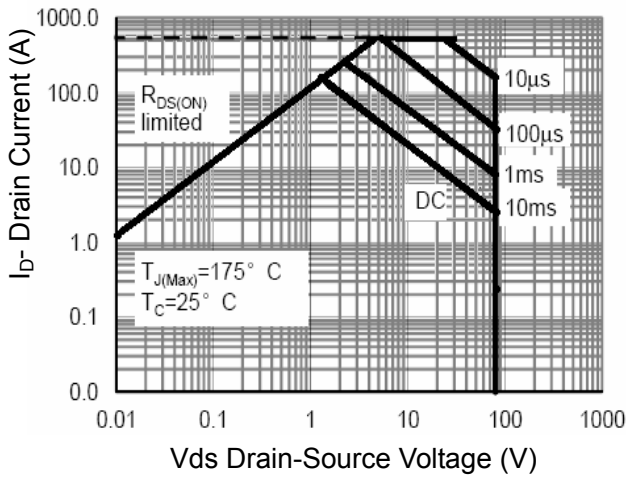

Figure 8 Safe Operation Area

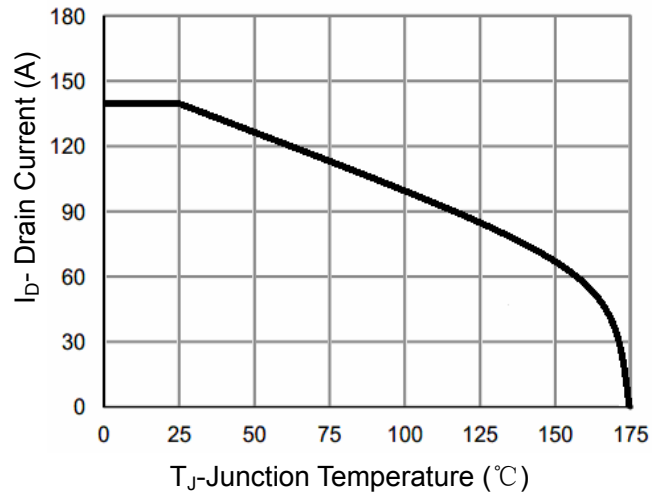

Figure 10 Current De-rating

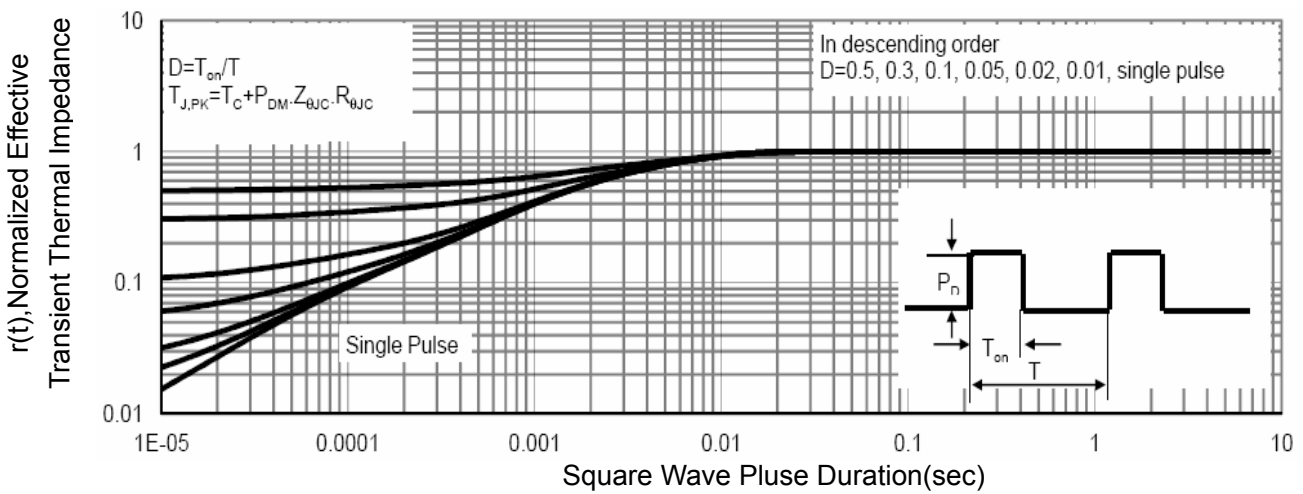
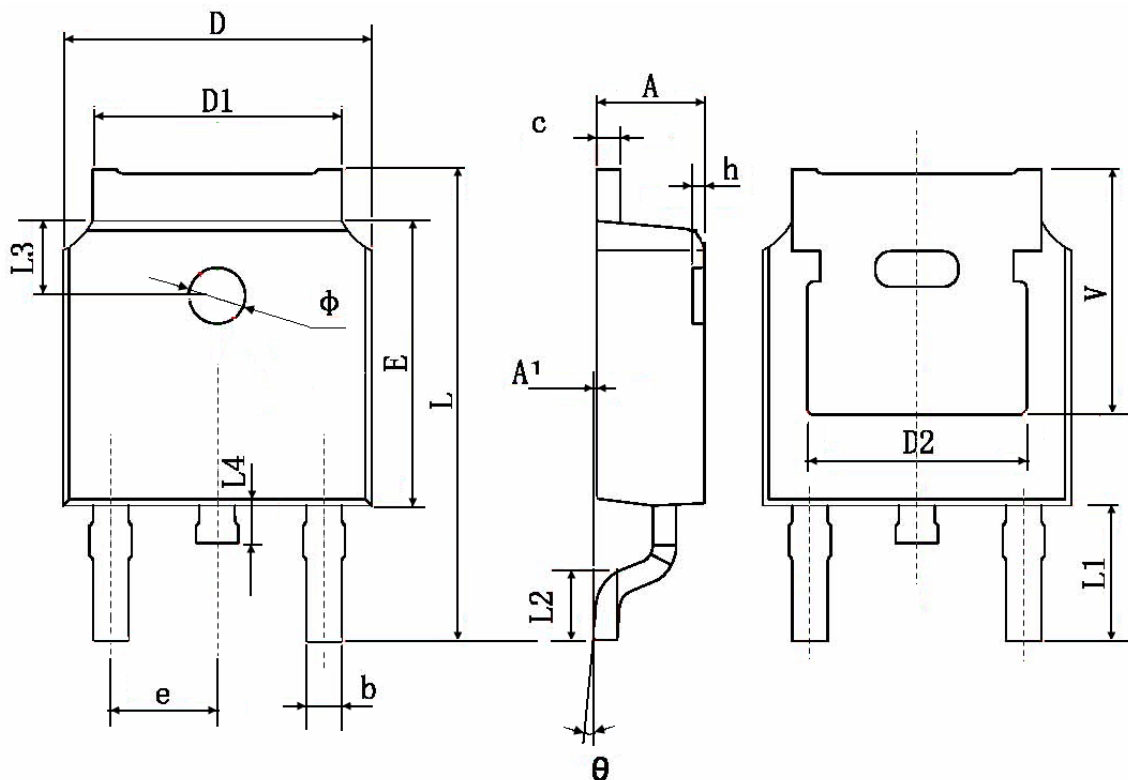

Figure 11 Normalized Maximum Transient Thermal Impedance

TO-252 Package Information



Symbol	Dimensions In Millimeters		Dimensions In Inches	
	Min.	Max.	Min.	Max.
A	2.200	2.400	0.087	0.094
A1	0.000	0.127	0.000	0.005
b	0.660	0.860	0.026	0.034
c	0.460	0.580	0.018	0.023
D	6.500	6.700	0.256	0.264
D1	5.100	5.460	0.201	0.215
D2	4.830 TYP.		0.190 TYP.	
E	6.000	6.200	0.236	0.244
e	2.186	2.386	0.086	0.094
L	9.800	10.400	0.386	0.409
L1	2.900 TYP.		0.114 TYP.	
L2	1.400	1.700	0.055	0.067
L3	1.600 TYP.		0.063 TYP.	
L4	0.600	1.000	0.024	0.039
phi	1.100	1.300	0.043	0.051
theta	0°	8°	0°	8°
h	0.000	0.300	0.000	0.012
V	5.350 TYP.		0.211 TYP.	

DFN5X6-8L Package Information

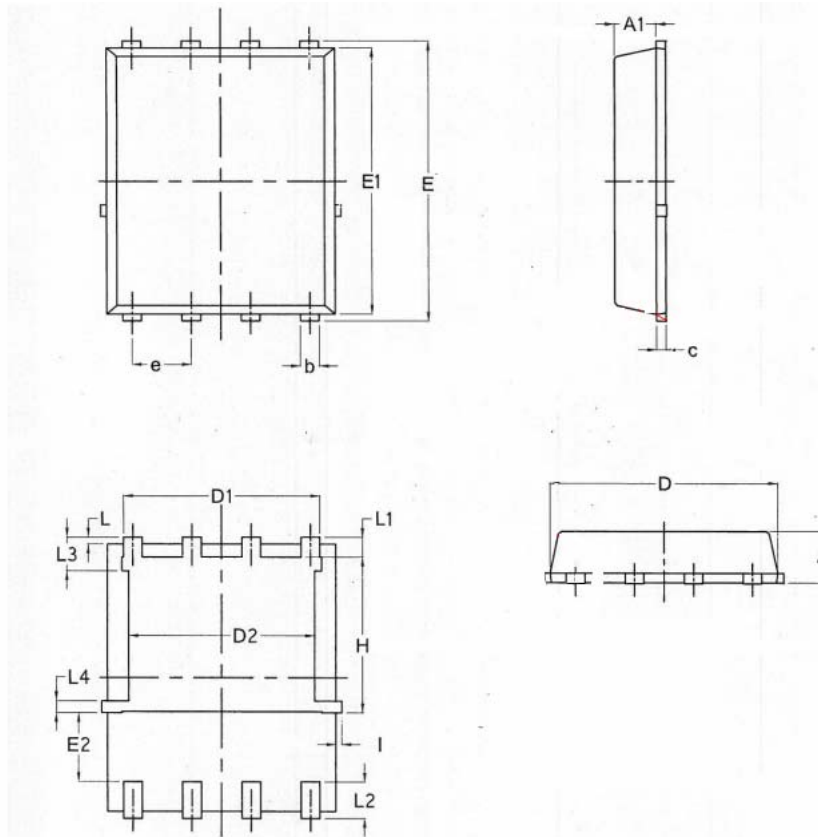

Symbol	Dimensions In Millimeters			Dimensions In Inches		
	Min.	Nom.	Max.	Min.	Nom.	Max.
A	0.90	1.10	1.17	0.0354	0.0433	0.0461
A1	0.824	0.897	0.97	0.0324	0.0353	0.0382
b	0.33	0.41	0.50	0.0130	0.0161	0.0197
C	0.150	0.20	0.250	0.0059	0.0079	0.0098
D	4.80	4.90	5.00	0.1890	0.1929	0.1969
D1	3.91	4.22	4.36	0.1539	0.1661	0.1717
D2	3.85	4.00	4.15	0.1516	0.1575	0.1634
E	5.90	60.5	6.15	0.2323	0.2382	0.2421
E1	5.65	5.76	5.85	0.2224	0.2268	0.2303
E2	1.10	/	/	0.0433	/	/
e	1.27 BSC			0.050 BSC		
L	0.05	0.15	0.25	0.0020	0.0059	0.0098
L1	0.38	0.425	0.50	0.0150	0.0167	0.0197
L2	0.51	0.785	0.86	0.0201	0.0309	0.0339
L3	0.55	0.70	0.85	0.0217	0.0276	0.0335
L4	0.10	0.25	0.40	0.0039	0.0098	0.0157
H	3.25	3.35	3.58	0.1280	0.1319	0.1409
I	0	/	0.18	0	/	0.0071